

Skylights by Supreme

Supreme Pro Series

Quality built skylights for every residential and light commercial application. Available in pitched or flat roof, with a variety of flashings, curb types and glazing options. Standard and custom sizes are available to be built to your specification.

AVAILABLE OPTIONS

- *Pitched Curb Flashing*
- *Flat Roof "Incline" Curb Flashing*

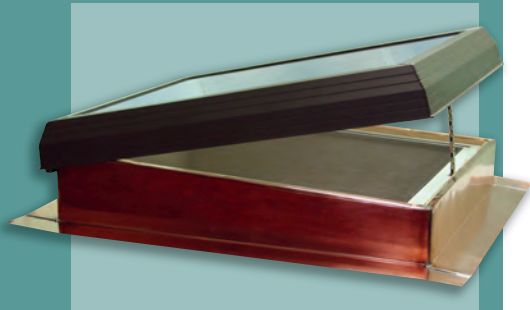

- *Step Flashing Kits*
- *Cut Flush Curb*
- *Factory Mullied Flashing*
- *Custom Sizes and Shapes*
- *Retrofit Flashing*

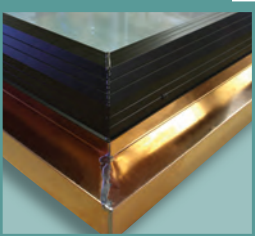

GLAZING OPTIONS

- *Clear Tempered Low E*
- *Bronze Tempered Low E*
- *Tempered Laminated*
- *Multi-Wall Polycarbonate*
- *Pattern Glass*

STANDARD FEATURES

- 1" Insulated Tempered Low E Argon Filled Glass
- Heavy Duty (6063 T-5) Aluminum Extruded cover Fully Welded and Powder Coated
- White Painted Pine Curb with Dado for Drywall
- Thermally Broken PVC Frame
- 16 oz. Copper Flashing

AVAILABLE STANDARD SIZES

Sizes are width x height and can be reversed (specify when ordering)

14x22	14x30	14x45	14x60	14x72	14x96
22x22	22x30	22x45	22x60	22x72	22x96
30x30	30x45	30x60	30x72	30x96	
45x45	45x60	45x72	60x60		

- Model numbers are also the outside curb dimensions
- Rough openings are 1/2" larger in width and height
- Custom sizes are available upon request

CURB OPTIONS

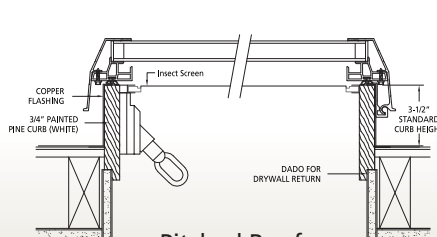

Pitched Roof Drop-In Curb

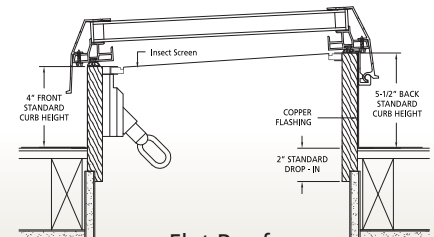

Flat Roof Drop-In Curb

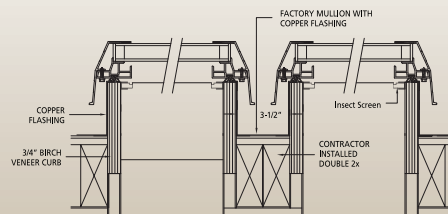

Factory Mullied Curb

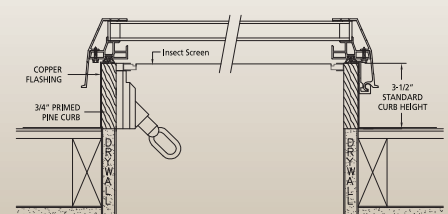

Cut Flush Curb

Replacement Hatch / Curb Mounted Skylights



Supreme Skylights will manufacture a replacement hatch to fit most skylight manufacturers. So if you have an existing skylight and only the top needs to be replaced, turn to us and we can make your old skylight new again.

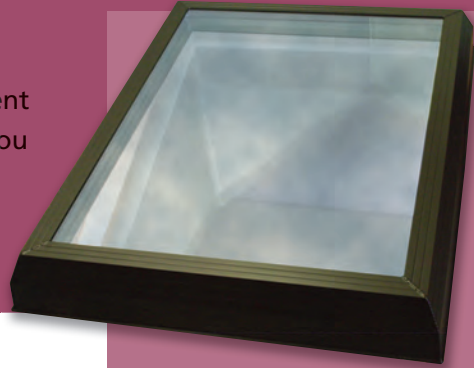

Vented Curb Mount Skylight

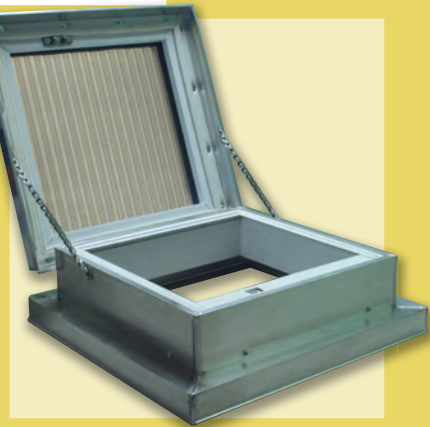

The perfect option for a retrofit skylight with either an existing curb or a new site built curb. This skylight has an easy worry free installation that offers ventilation, natural daylight, and roof egress. Standard and custom sizes are available.

STANDARD FEATURES:

- (Glazing) 1" Insulated Tempered Low E Argon Filled Glass or Multiwall Polycarbonate
- Heavy Duty (6063 T-5) Welded Mill Finish Aluminum Exterior
- Maintenance Free PVC Interior

STANDARD SIZES:

Outside Curb Dimension
25 ½ x 49 ½
37 ½ x 25 ½
37 ½ x 37 ½
49 ½ x 49 ½

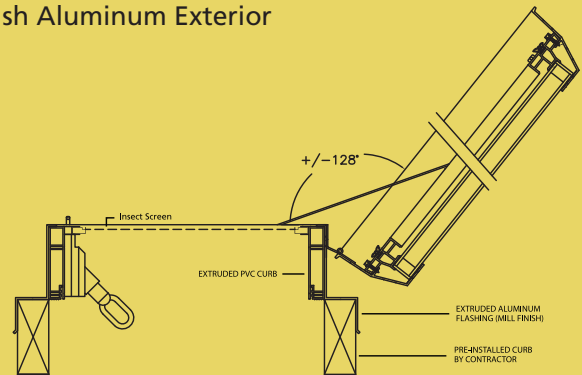

Accessories

- A** - Motorization Kits with Rain Sensor and Thermostat control options
- B** - Pleated Shades come standard with light filtering fabric, also available with room darkening fabric.
- C** - Manual Telescopic Pole
6 feet in length, extends to 10 feet.
- D** - Solar Motor with remote and Rain Sensor.



“ThinkGreen”

There are many environmental benefits of adding skylights to either residential or commercial spaces. Today more than ever architects, builders and homeowners are incorporating “green” products in their designs and renovation projects. Skylights are the single best source of allowing daylight and ventilation to occur due to their overhead location. In the spring and summer, allowing the warm interior air to escape while lighting the space below. During the fall and winter months allowing much needed sunlight while adding warmth to the interior space through the sun’s radiant heat. These are natural benefits of skylights without the use of electricity that would be required with either lighting or mechanical ventilation products.

Our manufacturing facility also operates with the environment in mind; we recycle all of our scrap raw material minimizing the waste going into our landfills. We have also partnered with multiple vendors who share the same philosophy and use recycled (post industrial waste) in the raw material they supply as well as internal recycling programs.

Our Story

Supreme Skylights Inc. located in Ronkonkoma, NY, designs and manufactures the highest quality skylights in the industry. We offer a full line of standard and custom sized skylights to fit most applications. Our products, which are built to last the lifetime of a home, utilize the highest quality materials, energy efficient glazing, and the finest workmanship.

Established in 2006 by individuals with decades of skylight manufacturing and sales experience, the company has grown rapidly. Supreme Skylights Inc. is recognized as a premier skylight brand and is preferred by architects, custom home builders and roofing contractors throughout the Northeast.

With our experienced and knowledgeable staff we will continue to expand our well respected brand and broad product line. It is this commitment to quality, service and dedication to our network of reputable distributors that makes us the “Supreme” choice for all of your skylight needs.

Limited Warranty

- 10 years on Workmanship
- 20 years on glass seal failure for tempered glass
- 20 years on glass seal failure for laminated glass
- Lifetime on hardware



2185 Fifth Avenue, Ronkonkoma, New York 11779

n 631.738.0324 W 631.738.0325

c www.supremeskylights.com



PRINTED ON
RECYCLED PAPER

